

EVE™ HT

User Manual



All the materials in this user manual are protected by Korean and International copyright laws. They cannot be reproduced, translated, published or distributed without the permission of the copyright owner.

EVE™ HT User Manual

Website: www.nanoentek.com

E-mail: sales@nanoentek.com

NanoEntek, Inc.

851-14, Seohae-ro, Paltan-myeon, Hwaseong-si, Gyeonggi-do, 18531, Korea

Tel: +82-2-6220-7940

Fax: +82-2-6220-7999

NanoEntek America, Inc.

220 Bear Hill Road, Suite 102, Waltham, MA 02451, USA

Tel: +1-781-472-2558

Fax: +1-781-790-5649

The information in this user manual is described as accurately as possible.

Firmware and software changes and updates may change without prior consent or notification.

Copyright © 2022 NanoEntek, Inc.

All right reserved. Published in Korea

Document number: **NESMU-EVEHT-001E (V.0.4)**

Revision history: V.0.0 MAR 2022

V.0.1 JAN 2023

V.0.2 FEB 2023

V.0.3 OCT 2023

V.0.4 MAY 2025

Table of Contents

Introduction

General Description	5
Components	6

Product Description

Front View	7
Upper Side View	7
Left Side View	8

Installation

Environmental Requirements	9
Powering on and Installation	10
Instrument Settings	11
Recommended Actions	16

General Operation

Sample Test

Sample Preparation	17
Measure	22

Quality Control

QC plate Preparation	28
QC plate Run	30
QC bead Preparation	32
QC bead Run	34

Data	37
-------------------	----

21 CFR Part 11

Log in	41
Data Status	41
Approval	42
Setting	44
User manage	45
Log manage, Document manage, Deleted list	47

Maintenance and Cleaning	48
---------------------------------------	----

Trouble Shooting	49
-------------------------------	----

Error Message	50
----------------------------	----

Warranty	51
-----------------------	----

Technical Specifications	52
Ordering information	53
Safety Precautions	54
Explanation of Safety Symbols	56
Warnings	58
Technical Support	59

General Description

EVE™ HT is an automated multi-cell counter designed to count number of cells and measure viability of cells using trypan blue exclusion method. EVE™ HT uses automated image acquisition and proprietary image analysis method to quantify cell numbers and viabilities.

EVE™ HT requires only 20 µL of samples to run measurements. EVE™ HT Counting Plate is a disposable plate with 48 channels which allows EVE™ HT can measures 48 samples simultaneously.

EVE™ HT can count a wide variety of eukaryotic cells. EVE™ HT also measures the distribution of cell size measured under bright field imaging. EVE™ HT offers advanced algorithm to handle irregular shaped cells and declustering algorithm to handle clumped cells.

EVE™ HT has little user-to-user variations and it provides consistently accurate results regardless of whoever the user may be.

EVE™ HT offers optional "21 CFR part 11 module" to safeguard all the records and data in compliance to the FDA requirements.



Components

EVE™ HT is shipped with the following components.

Upon receiving the instrument, please check that all items listed below are included in the shipment. If any of the items are missing or damaged, contact your local distributor or sales@nanoentek.com.

EVE™ HT

1 EA



Multi pipette

1 EA



Operating desktop

1 SET



EVE™ HT Counting kit

1 EA



EVE HT COUNTING KIT

EVE™ HT Accessories

Preparation plate (optional)
QC plate (optional)

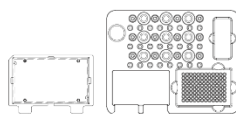

QC PLATE
(Low/Middle/High)

PREPARATION PLATE

EVE™ HT 21 CFR Part 11 software (optional)

Front View

Front view showing various parts of EVE™ HT.

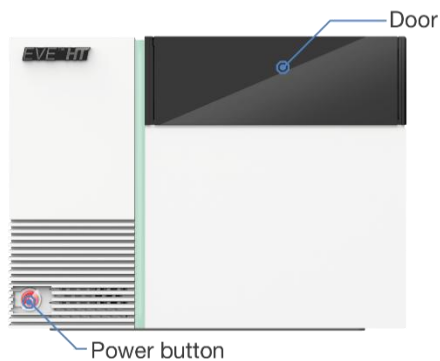

Part name	Description
Power button	Powering on/off
Door	Instrument door

Upper Side View

Upper side view showing various parts of EVE™ HT.

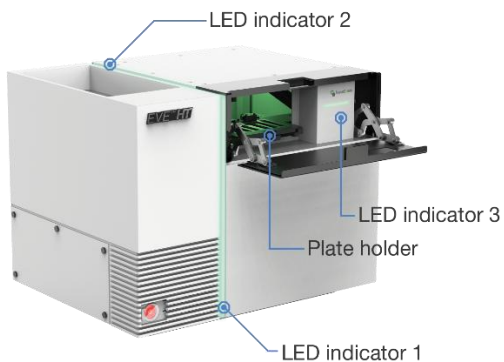

Part name	Description
LED indicator	Product status display
Plate holder	Holder for plate when inserted/ejected

Left Side View

Left side view showing various parts of EVE™ HT.

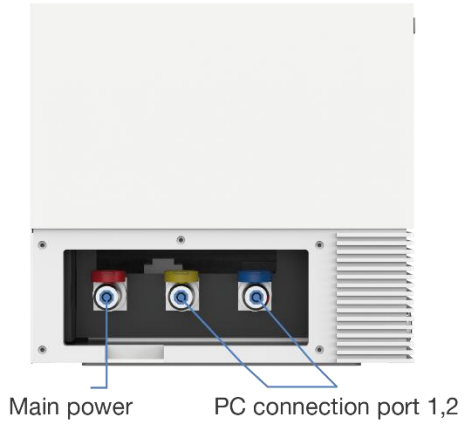

Part name	Description
Main power	Connection port for electrical outlet
PC connection ports	Connection ports for PC

Environmental Requirements

CAUTION

At low temperature (≤ 10 °C), allow the instrument to warm up for 10 minutes at ambient temperature before use.

To ensure correct operation and stable performance, install EVE™ HT in a proper location by complying with the followings:

- Use at room temperature.
- Do not expose the instrument to direct sunlight.
- Do not expose the instrument to direct or continuous vibration.
- Do not expose the instrument to intense magnetic or electromagnetic fields.
- Do not install the instrument in high-humidity environment.
- Installation should be free corrosive gases or other corrosive substances.
- Minimize contact with dust or airborne particles.
- Secure at least 10 cm (4 inches) of free space around the instrument for the proper airflow.
- Do not place objects on top of this instrument.
- Connect EVE™ HT power cord to wall outlet directly.

Powering on and Installation

1. Connect the EVE™ HT with the color-coded power cord and connection cords of PC.

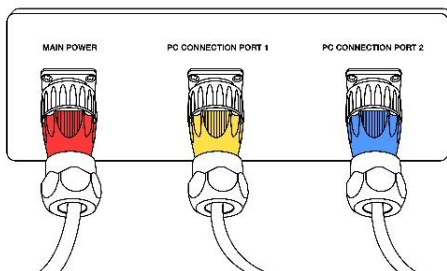

2. Connect the EVE™ HT to PC with LAN and USB cable.
3. Connect the PC to a PC monitor using a monitor cable. Then, connect the power cords to the PC and PC monitor.

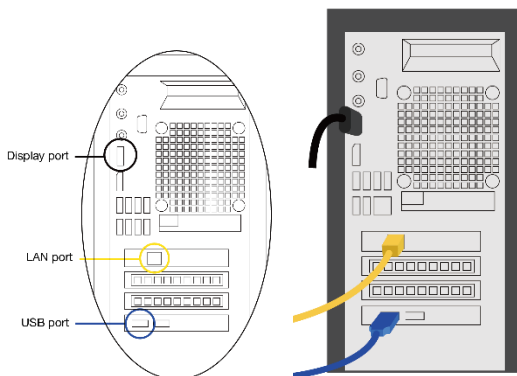

CAUTION

- Do not tilt the instrument too much when connecting the power cord.
- Do not move the instrument after connected to the power cord.

4. Turn on EVE™ HT instrument.
5. Turn on the PC and run EVE™ HT main software.

CAUTION

If the error code occurs during the program initializing process, turn off the instrument and the PC. Repeat Step 4 and 5 above. If the same error message appears repeatedly, contact your local distributor or sales@nanoentek.com.

Instrument Settings

Press '**SETTING**' from the startup screen. The setting menu allows you to set up the followings.

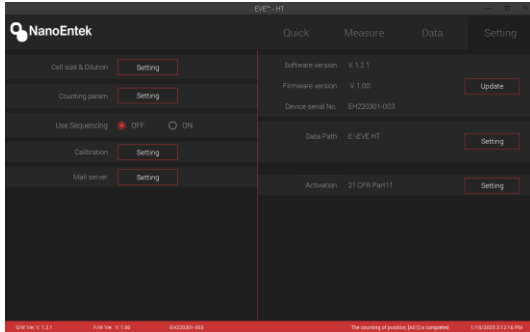

1. Click '**Calibration**' to calibrate the instrument image background level.

a) Calibration sample preparation

- ① Mix **20 μ L of culture media** and **20 μ L of trypan blue** thoroughly.
- ② Load **20 μ L of the mixture** into one channel in an EVE™ HT Counting Plate.
- ③ Insert the counting plate into the plate holder of the instrument.

b) Calibration setting

- ① Select '**Setting**' tab.
- ② Click **Calibration 'Setting'** button.
- ③ Click '**Insert**' button.
- ④ Select the **wells** loaded with the mixture

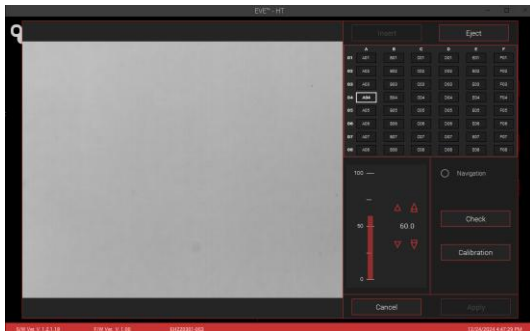

Instrument Settings

⑥ Click **'Check'** button.

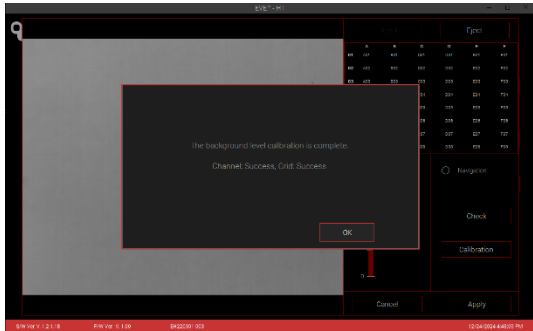

⑦ Click **'Calibration'** button.

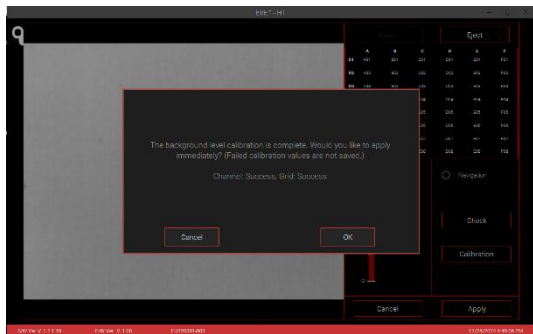

⑧ After finish the calibration, click **'OK'** and **'Apply'** button.

2. Set the **minimum and maximum cell size**.

3. Set the **dilution factor** according to the test.

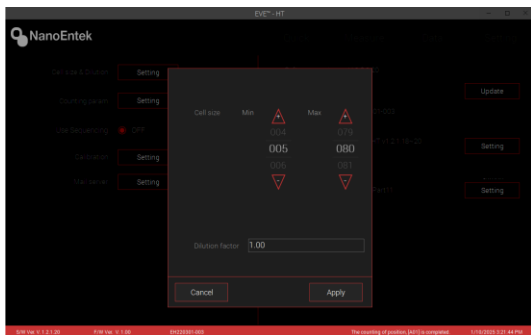

NOTE

Mix ratio (sample 20 μ L + Trypan Blue 20 μ L) is already applied so do not apply to dilution factor.

Instrument Settings

4. Set the Counting parameter.

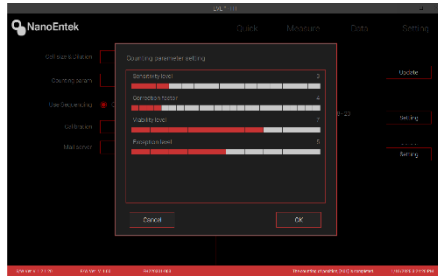

It is highly recommended that users use default counting parameters. However, depending on cell types and media conditions, one may need to adjust these counting parameters.

① Sensitivity level

As this level gets lower, it becomes easier to remove the effects of debris.

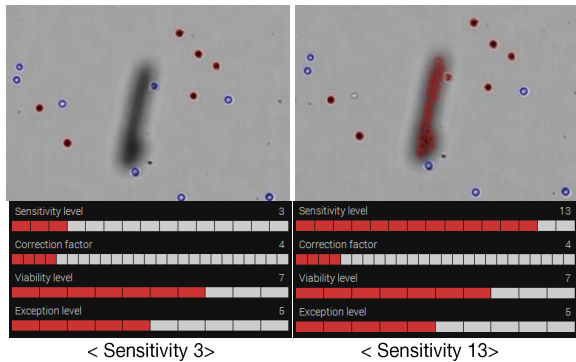

② Correction factor

As this factor gets lower, the software becomes more sensitive to pick up vague objects.

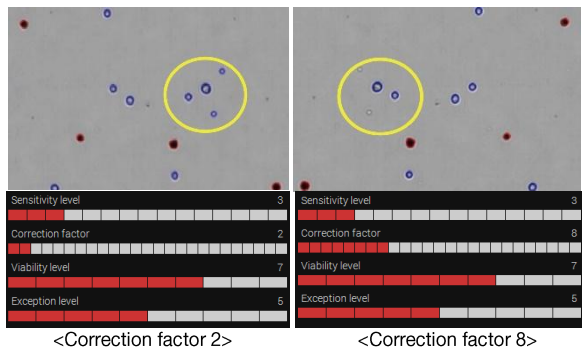

Instrument Settings

③ Viability level

As this level gets higher, marginally dark objects won't be counted as dead cells.

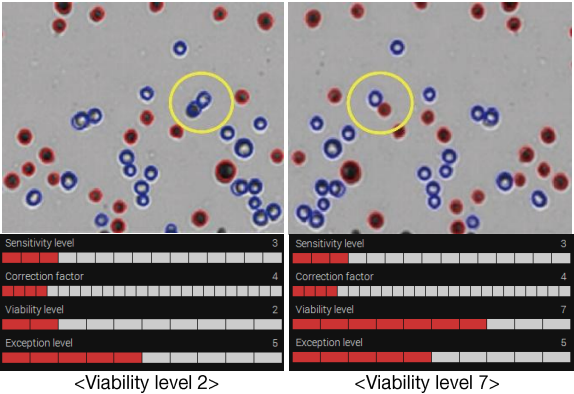

④ Exception level

As this level gets lower, the software becomes more sensitive to pick up small objects. This is useful for counting aggregation samples or small cells.

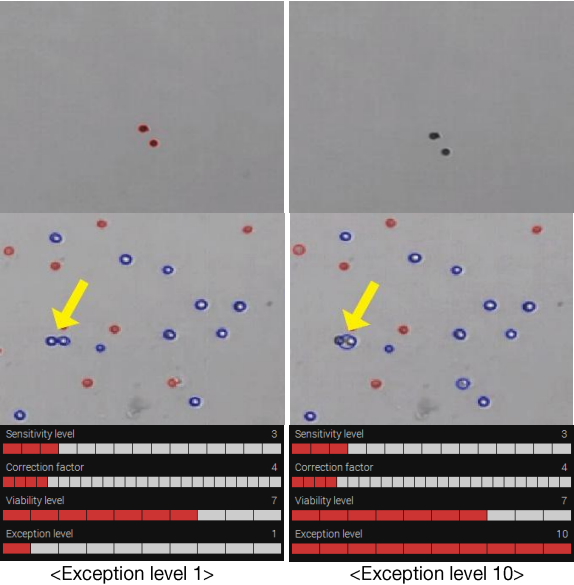

Instrument Settings

5. Use Sequencing

- ① Default setting for assigning sequential number after the sample name.

6. Update to install new **software** or **firmware** as they become available.

- ① Connect the **USB** with the update file to computer.
- ② Click '**Update**' button in setting tab.

7. Data Path

- ① Click Data Path '**setting**' button in setting tab.
- ② Set the data storage path.

8. Mail server

**Do not change Mail settings.*

9. 21 CFR Part11

- ① 21 CFR PART11 is a separately purchased function. A detailed description is at the end of the manual.

Recommended Actions

To obtain the best results, follow these recommendations:

1. Sample

- ① Wear protective gloves while handling samples.
- ② For accurate results, ensure that samples are well mixed.
- ③ Also, allow loaded samples to settle for **2 minutes** before Focus setting.

2. Trypan blue

- ① Warm up to room temperature before use in order to avoid debris.

3. EVE™ HT Counting Plate

- ① Keep the Counting Plate in the carriage and use on a clean table to prevent dust from sticking.
- ② Do not touch any surfaces except for the handles
- ③ Ensure that the sample fills up entire channel.
- ④ Do not tilt the plate after loading the sample.
- ⑤ Do not insert the plate upside-down as this may cause liquid to flow into the instrument and cause damage.
- ⑥ Do not re-load the sample into used channel. One can use same plate multiple times as long as new channel(s) are used each time.
- ⑦ Make sure to push the plate all the way in.

4. Instrument

- ① Use EVE™ HT at room temperature only (20 ~ 25 °C).
- ② Turn on the instrument before the EVE™ HT software.
- ③ Do the background calibration when using trypan blue with a new lot number. (Refer to page 11).
- ④ Make sure the door and plate holder are closed.

Sample Test

Sample Preparation

Instruction is provided in this chapter for preparing the sample using EVE™ HT trypan blue stain and disposable EVE™ HT Counting Plate.

1. Prepare cell suspensions either in growth media or PBS
2. Thoroughly **mix the cell pellet** by vortexing.
3. Dilute cell solutions so that expected final concentration will be between 1×10^4 and 1×10^7 cells/mL.
4. Load **20 μ L of well-mixed sample** into a mix well plate. Small volume PCR plates are included in EVE™ HT kit to be used as mix well plates.

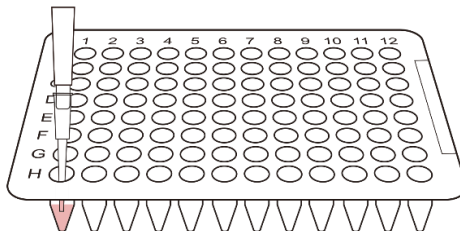

5. Dispense enough amount of **trypan blue** to a reservoir. Disposable reservoirs are included in EVE™ HT kit.
6. Add **20 μ L of trypan blue** to the sample-loaded well using multi pipette and **mix the sample and trypan blue by pipetting up and down**. A 8-channell multiwell pipette is included in each EVE™ HT.

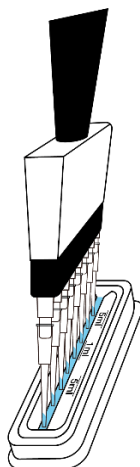

Sample Test

Sample Preparation

7. Load **20 μ L of sample mixture** into the EVE™ HT Counting plate.

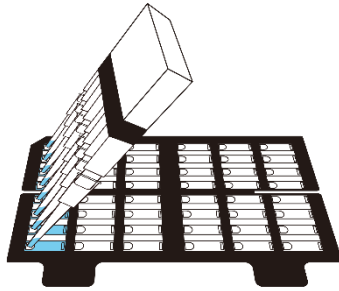

NOTE

EVE™ HT can analyze cell concentrations of 1×10^4 to 1×10^7 cells/mL.

Correct and incorrect example of loaded sample

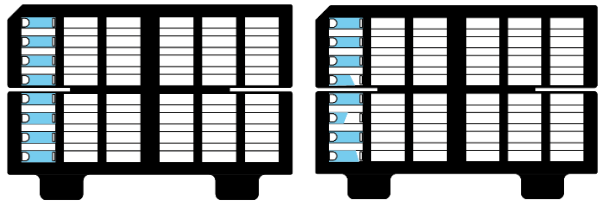

Correct

Incorrect

8. Open the EVE™ HT door and press **plate holder cap** to open the plate.

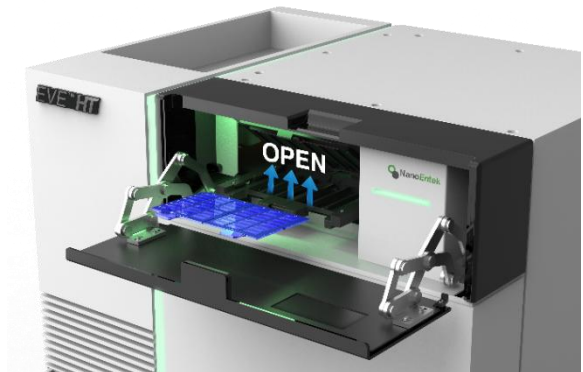

Sample Test

Sample Preparation

9. Insert the **EVE™ HT Counting plate** loaded with sample into the plate holder.

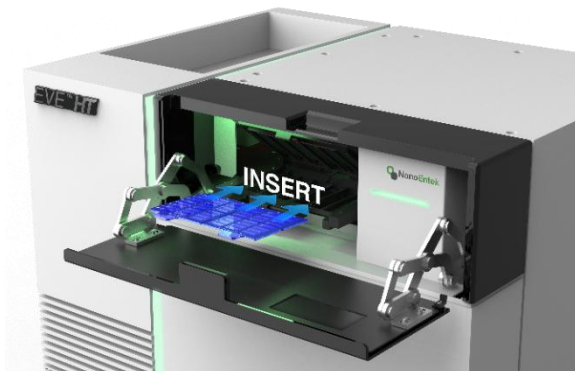

10. First close the **plate holder**, then close the **door**.

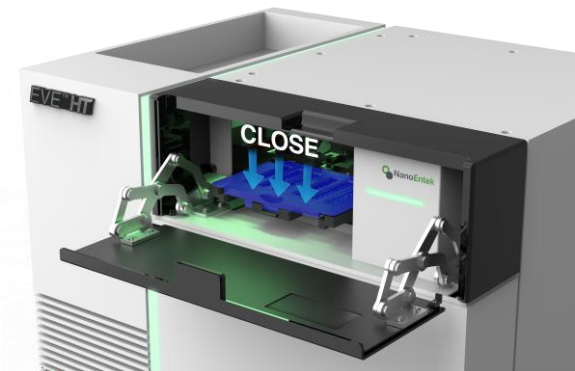

⚠ CAUTION

Allow sample to settle for '2 minutes' after inserting the EVE™ HT Counting Plate into the instrument.

⚠ CAUTION

Make sure to put the plate all the way in when inserting the plate.

⚠ CAUTION

Make sure to properly close the door and plate holder cover before operating.

Sample Test

Quick Count

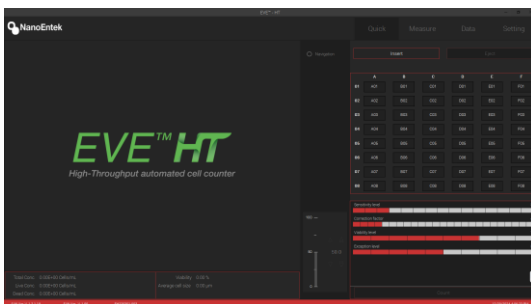

Quick count tab

The quick count function captures the displayed image in real time and counts one frame.

1. Click the **'Insert'** button.
2. After finish the insert the plate, click the **sample loaded well**.
3. Set the **focus** following the focus guide.
4. Adjust the **focus** using the **'focus'** buttons.

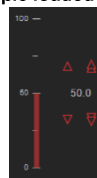

* Fine focus: Hold **'Shift or Control'** button and **scroll the mouse wheel** over the image for adjustment.

* Focus example

a) Good focus

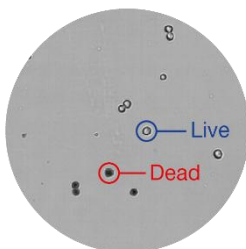

- ▶ Live cells have bright centers and dark edges.
- ▶ Dead cells have a uniformly blue color throughout the cell with no bright centers.

b) Bad focus

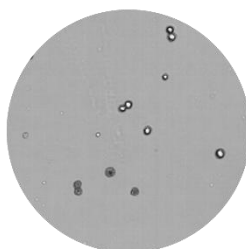

- ▶ Dead cells have bright centers and blurry boundaries.

Sample Test

Quick Count

c) Bad focus2

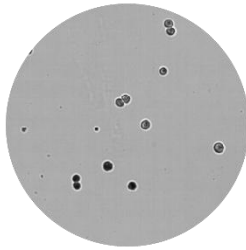

► Live cells with dark centers are counted as the dead cells.

5. Check the **counting parameter**.
6. Click the **'Count'** button.
7. The results are displayed on the **Quick Count section** from the **Data** menu.

Sample Test Measure

This section provides procedures and tips for cell counting using EVE™ HT.

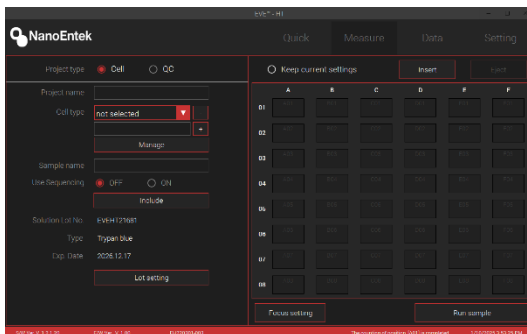

Measure tab

1. Click 'Measure' tab.
2. For project type, select 'Cell' and enter 'Project name'.
3. Select 'Cell type' and enter 'Sample name'.

* Cell type

a) Make the new cell type.

- ① Enter the name of cell type.
- ② Click the '+' button.
- ③ Set the 'Cell size' and 'Dilution factor'
- ④ Click the 'Apply' button.

b) Using the previous cell type

- ① Click the '▽' button.

- ② Select the cell type.

c) Delete the cell type

- ① Click the '▽' button.
- ② Select the cell type.
- ③ Click the '-' button.
- ④ Click the 'OK' button.

d) Manage the cell type.

- ① Click the 'Manage' button.
- ② Select the cell type.
- ③ Set the cell size and dilution factor.

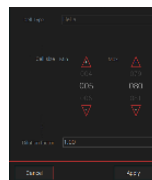

Sample Test Measure

④ Click the 'Apply' button.

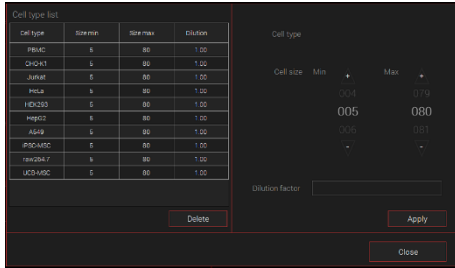

4. Select the wells loaded with samples. For individual selection, click each well you want to measure. For group selection, left click and drag.

5. Click 'Include' button or choose 'Include' option from 'Select' menu by right click. Then, make sure the selected wells are displayed in red.

6. Repeat Step 3 to 5 for remaining wells.

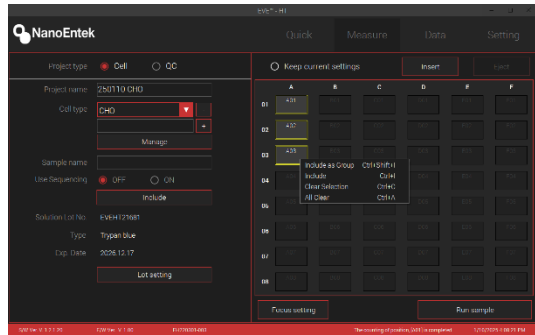

Before include

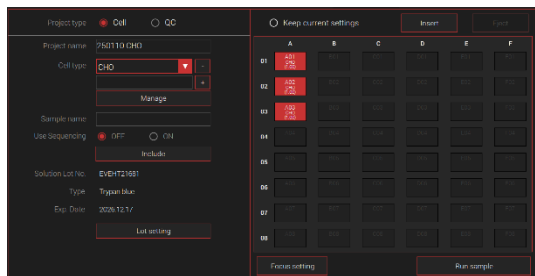

After include

* After entering the sample name, set 'Use Sequencing' to 'ON', and click 'Include', a sequential number is assigned to the sample name.

Sample Test Measure

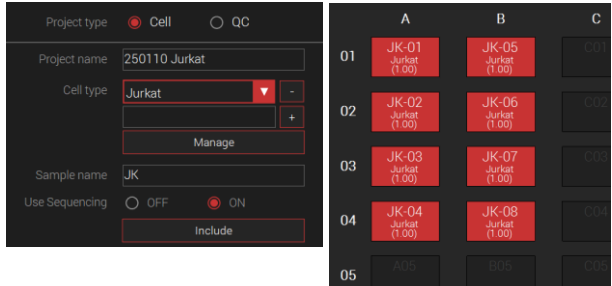

* Use the previous Well setting.

- A. Click the 'Keep current setting' on measure tab.
- B. Well setting format

User can edit the well setting in excel file.

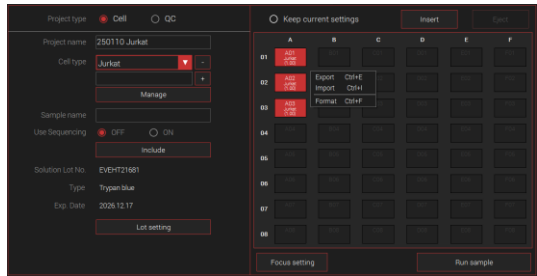

a) Export

- ① Click the 'right' button of the mouse in the Well Setting window.
- ② Click the 'Format' or 'Export' and enter the file name and pathway.

Sample	Include	Group	Name	Cell type	Size min	Size max	Dilution	Sample	Include	Group	Name	Cell type	Size min	Size max	Dilution
A01	X				5	80	1	A01	O						
A02	X				5	80	1	A02	O						
A03	X				5	80	1	A03	O						
A04	X				5	80	1	A04	X						
A05	X				5	80	1	A05	X						
A06	X				5	80	1	A06	X						
A07	X				5	80	1	A07	X						
A08	X				5	80	1	A08	X						
B01	X				5	80	1	B01	X						
B02	X				5	80	1	B02	X						
B03	X				5	80	1	B03	X						
B04	X				5	80	1	B04	X						
B05	X				5	80	1	B05	X						
B06	X				5	80	1	B06	X						
B07	X				5	80	1	B07	X						
B08	X				5	80	1	B08	X						

Format

Export

b) Edit

- ① Open the excel file.
- ② Edit the file (Include, Group, Name, Cell type, Size min, Size max, Dilution) and save.

Sample Test Measure

c) Import

- ① Click the 'right' button of the mouse in the Well Setting window.
- ② Click the 'Import' and select the excel file.

NOTE

If the parameters in the Excel file do not match the values of the Cell type, the values from the Excel file will take priority, and the Cell type parameters will be updated accordingly.

7. Adjust the focus using the 'Focus Setting'.

NOTE

Load the Counting plate in the plate holder and perform 'Focus setting' after 2 minutes.

8. Set the 'counting parameter'. Refer to the page 13-14.

9. Click 'Check' button to check live and dead cells at the current focus location. Refer to the page 20-21.

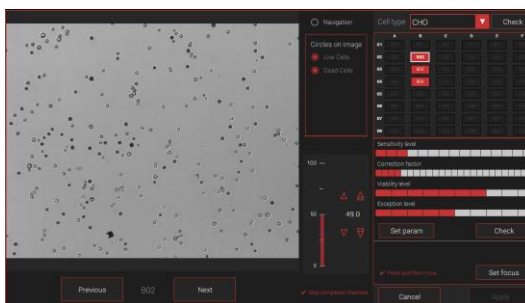

Focus setting

Navigation	Navigation on/off.
Circles	Circle (Live Cells / Dead Cells) on/off
Cell type	Select the cell type to set focus on and check it.
Set param	Set parameters.
Check	Count the cells on the current screen using the Quick count method.
Set focus	Apply the focus value.
Press and then move	After applying the focus setting, move to the next channel.
Skip completed channels	Channels that have been focused will be skipped.
Previous/Next	Previous/Next move buttons

Sample Test Measure

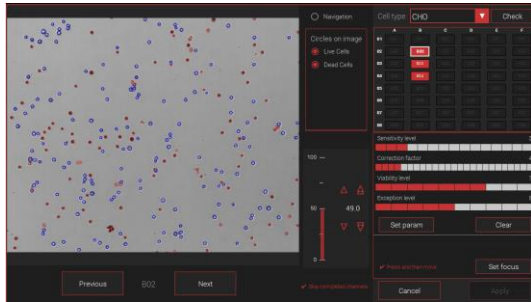

Check

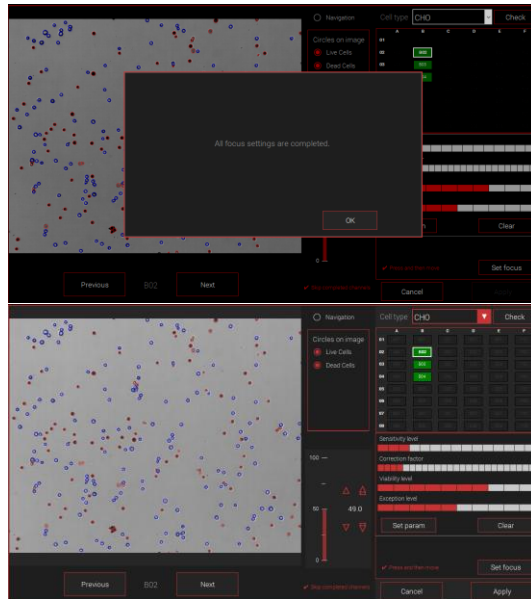

Set Focus

10. After confirming the desired settings, click 'Set Focus' and 'Apply' button.

11. Click the 'Run sample' button.

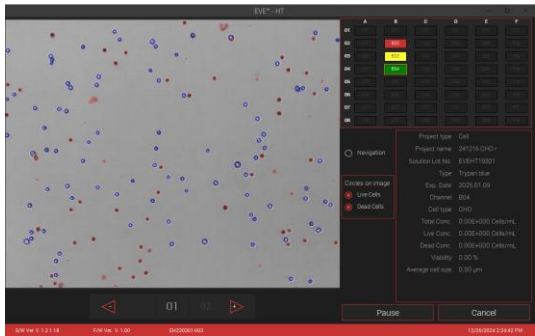

Running

* During measurements, results for wells already counted can be checked while counting other remaining wells.

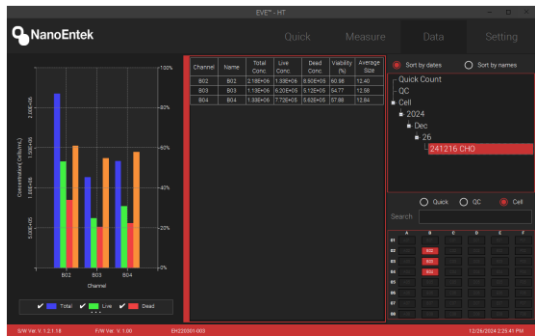

12. The results are displayed on the Cell section from the Data menu.

Quality Control

QC plate Preparation

This is for quality control using **QC plate**. Follow the instruction below only if necessary.

1. Prepare the **QC plate**.



2. Open the EVE™ HT door.
3. Push the **plate holder cap** to open up the plate holder.

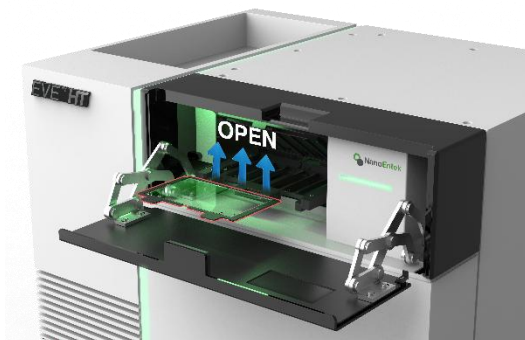

4. Insert the **QC plate** into the plate holder of the instrument.

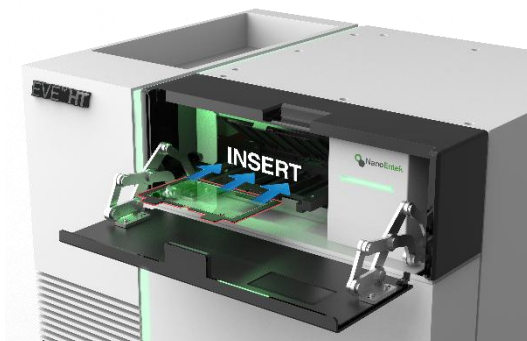

⚠ CAUTION

Make sure to push the plate all the way in.

Quality Control

QC plate Preparation

5. First close the **plate holder**, then close the **door**.

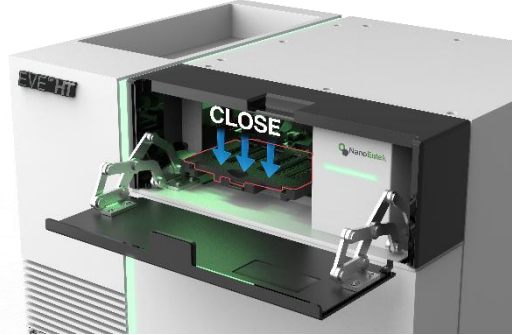

⚠ CAUTION
Make sure the door and plate holder are properly closed.

Quality Control

QC plate Run

1. Select menu & QC plate Lot setting

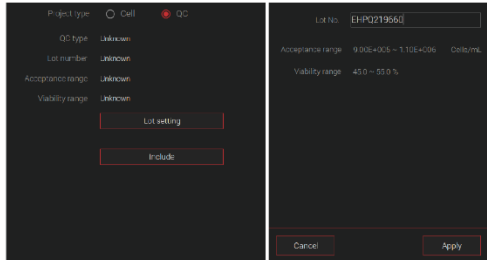

- 1 Click the **'Measure'** tab.
- 2 Select the **'QC'** on the project type.
- 3 Click the **'Lot setting'**.
- 4 Click the **'New'** button for creating the new lot.
- 5 Enter the **'Lot number'**.
* The lot number can be found on the plastic package label.
* The last lot used will be automatically applied from the next time.
- 6 Click the **'Apply'** button and check the **'Acceptance range'**.

2. Using previous lot

- 1 Click **'Lot Setting'** button and find the lot number from **'Search'** tab.
- 2 Select the lot you want and click **'Apply'** button.

3. Well setting

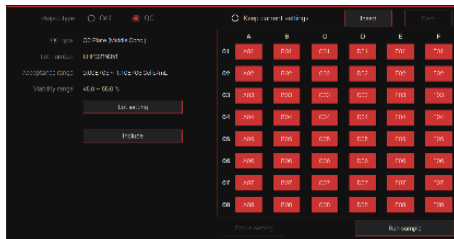

- 1 Select all 48 channels, then click **'Include'** button or select **'Include'** option from **'Select'** menu by right click. Make sure the selected wells are displayed in red.
- 2 Well setting can be edited from the **'Select'** menu.
- 3 QC Plate does not require a focus setting procedure because the auto focus function is applied.

Quality Control

QC plate Run

4. Run Sample

- ① Click the **'Run sample'** button.
 - * During measurements, results for wells already counted can be checked while counting other remaining wells.
- ② The results are displayed on the **QC section** from the **Data** menu.

5. Data Analysis

Select the **'Data'** tap to check the results. The result of performance test should meet the **'Acceptance range'** in the QC Plate.

- **Acceptance range:**

- **Low level** (Cat. no. EHPQ-001)
Cell concentration : $6.96 \times 10^4 \sim 1.04 \times 10^5$ cells/mL
Viability : 25.0 ~ 35.0 %
- **Middle level** (Cat. no. EHPQ-002)
Cell concentration : $9.00 \times 10^5 \sim 1.10 \times 10^6$ cells/mL
Viability : 45.0 ~ 55.0 %
- **High level** (Cat. no. EHPQ-003)
Cell concentration : $4.50 \times 10^6 \sim 5.50 \times 10^6$ cells/mL
Viability : 75.0 ~ 85.0 %



Quality Control

QC bead Preparation

This is for quality control using **Bead Solution**. Follow the instruction below only if necessary.

1. Let the **Bead Solution** come to room temperature for up to **10 minutes** before use.
2. Shake bottle vigorously or vortex briefly for 5 seconds before use.

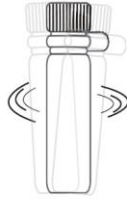

[Shake bottle vigorously]



[Vortexing]

3. Vortex again for 4 seconds and pipette immediately.

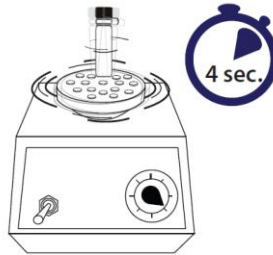

[Vortexing]

4. Transfer **20 μ L of calibration bead** to the Mix Well Plate, add **20 μ L of trypan blue**, and mix well by pipetting up and down.

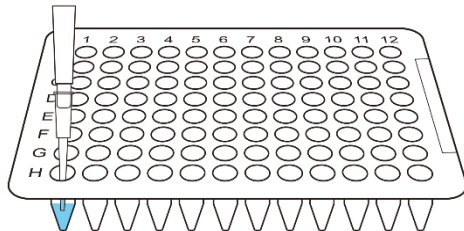

Quality Control

QC bead Preparation

5. Load **20 μL of mixture** into each channel of EVE™ HT Counting plate.

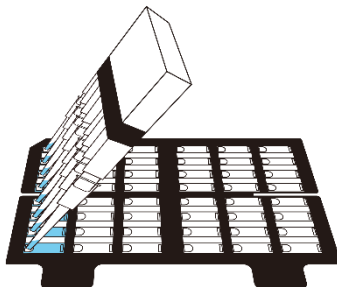

Correct and incorrect example of loaded sample

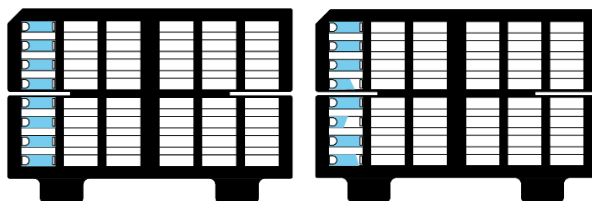

Correct

Incorrect

6. Open the EVE™ HT door.
7. Push the **plate holder cap** to open up the plate holder.
8. Insert the **plate** into the plate holder of the instrument.

⚠ CAUTION

Make sure to push the plate all the way in.

📌 NOTE

Allow beads to settle for '1 minute' after inserting the EVE™ HT Counting plate to the instrument.

9. Close the **plate holder** first then the **door**.

⚠ CAUTION

Make sure the door and plate holder are properly closed.

Quality Control

QC bead Run

1. Select menu & QC bead Lot setting

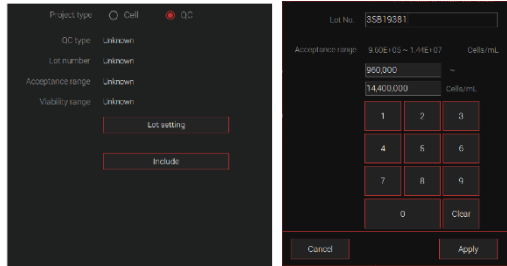

- ① Click the **'Measure'** tab.
- ② Select the **'QC'** on the project type.
- ③ Click the **'Lot setting'** button.
- ④ Click the **'New'** button for creating the new lot.
- ⑤ Enter the **'Lot number & Acceptance range'**.
 * The lot number & acceptance range can be found on the plastic package label.
 * The last lot used will be automatically applied from the next time.
- ⑥ Click the **'Apply'** button and check the **'Acceptance range'**.

2. Using previous lot

- ① Click **'Lot Setting'** button and find the lot number from **'Search'** tab.
- ② Select the lot you want and click **'Apply'** button.

3. Well setting

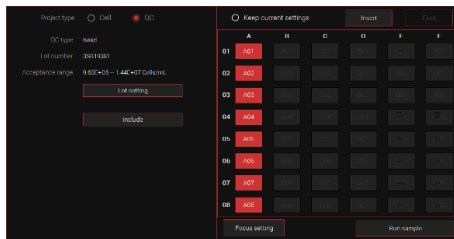

- ① Select the **wells** loaded with samples. Click or drag to select the wells you want to measure.
- ② Click **'Include'** button or select **'Include'** option from **'Select'** menu by right click. Make sure the selected wells are displayed in red as shown.
- ③ Well setting can be edited from the **'Select'** menu.
- ④ Click **'Focus Setting'**.

Quality Control

QC bead Run

4. Focus setting

① Adjust the focus using the focus buttons.

* Fine focus: Hold '**Shift**' or '**Control**' button and **scroll the mouse wheel** for adjustment.

* **Focus example**

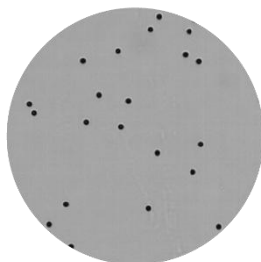

Good focus

► Beads have a uniformly dark color throughout the beads with no bright centers.

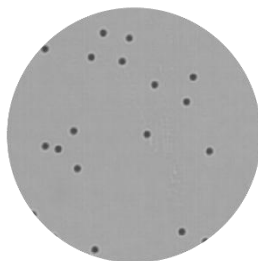

Bad focus

► Beads have blurry boundaries.

② Click '**Set Focus**' button.

③ Click '**Apply**' button.

5. Counting and getting result

① Click '**Run sample**' button.

② During measurements, results for wells already counted can be checked while counting other remaining wells.

③ The results are displayed on the **QC section** from the **Data** menu.

Quality Control

QC bead Run

6. Data Analysis

The result should be **within the range on the label** of the QC bead bottle. (e.g. $8.0E+05 \sim 1.2E+06/\text{mL}$)



Data

Data menu allows users to review the raw data including counting results and images from each well. Reviewing, editing, saving and exporting the data can be done.

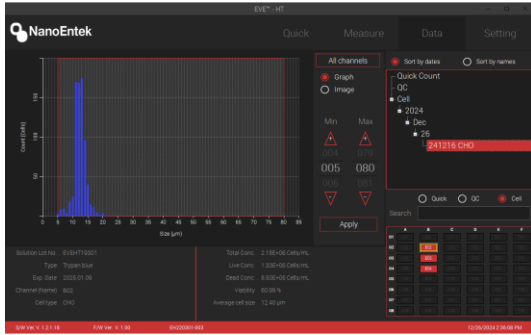

Data menu (Well graph)

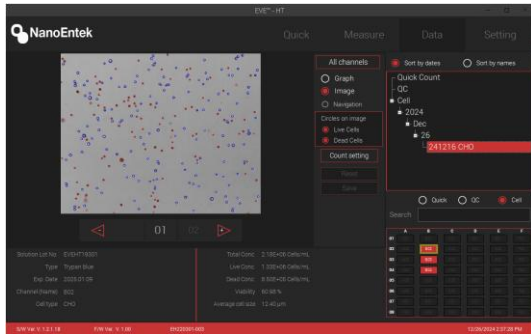

Data menu (Well image)

Data

1. Data list

When counting is complete, all the information is automatically stored in the data list. This list can be sorted by either date or name.

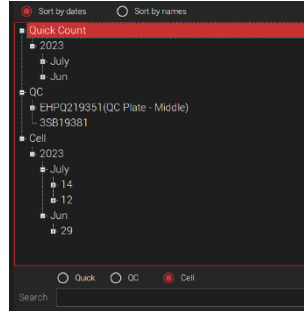

Quick Count	Data list taken from the Quick menu.
QC	Data list taken from the QC mode (Project type).
Cell	Data list taken from the Cell mode (Project type).
View type	It can be viewed by two criteria, date or name.
Search	Search the data in each section.

2. Graph

Lot graph in QC mode	<p>Period of date can be set. (Day, Month, Year or Index)</p> <ul style="list-style-type: none"> • Maximum of 48 counting results will be displayed on the graph and the data list. • The graph and table of well are linked. When you select the data on the graph, the corresponding well will be displayed in the table. When you double click the well in the table, the corresponding well will be displayed.
-----------------------------	--

Plate graph in QC and cell mode



Data

- Value for minimum and maximum cell size can be set in **Size graph**.
- Minimum and maximum cell sizes are used to determine the low and high ranges of cell size for measurement.

Graph in well

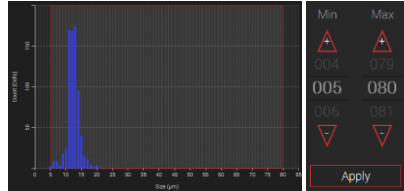

Users can edit the following functions through the captured image:

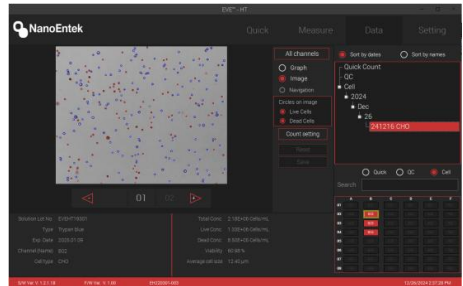
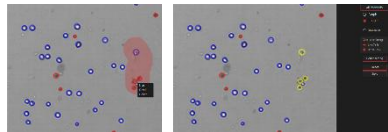

Image in well

- Circle (Live Cells / Dead Cells) on/off
- Navigation on/off
- Image editing:



- ① Right-click on the circle to go to menu. Right-click and drag images for multiple selection.
- ② Click live, dead or debris.
- ③ Click '**Save**' button to apply or '**Reset**' button to cancel.
- ④ Change the Counting parameter. Refer to the page 13-14.

Data

3. Edit function

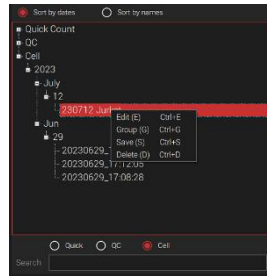

- **Right-click** on each project or well to go to menu.

Edit

Rename the project name.

Set the Size gating and dilution factor. Set the Acceptance range is only possible in QC data.

✓ Edit can be modified in selected multi-wells.

To re-edit group setting, select **Group**.

Group

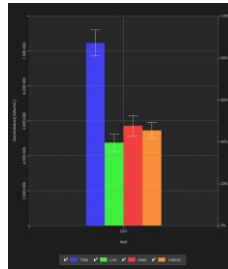

Save

To save project, select **Save**.

✓ The data type and pathway can be selected.

Delete

To delete project, select **Delete**.

21 CFR Part 11 Log in

When activating 21 CFR Part11, the user must log in on the first screen.

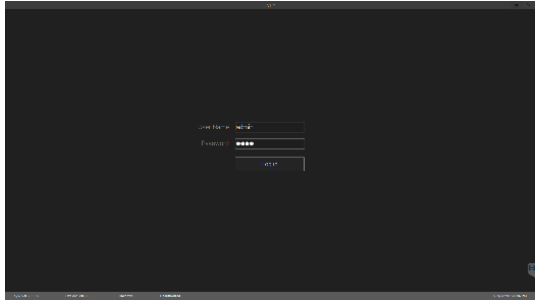

*Log in from login screen. (default ID/PW : admin/0000)
*Log out is in the User tab.

21 CFR Part 11 Data Status

Users can check data status upon 21 CFR Part11 activation.

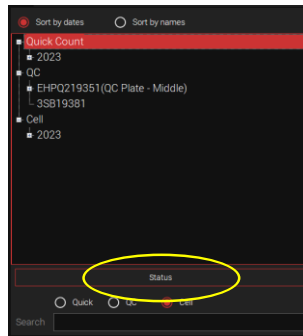

Data list

Data processing status

Project Name	Project Create Date	Owner	Auto sign	Signed	Requester	Request Date	Approver	Approval Date	Status
0000074_153837	2020/11/15 09:37	admin	x	x					Not progress
0000074_101028	2020/11/10 09:28	User	x	x	User	2020/11/10 01:01	admin		Request in progress
0000075_44944	2020/11/11 14:36	admin	x	x	admin	2020/11/10 09:01	admin	2020/11/10 09:01	Approved
0000076_143544	2020/11/14 09:53	admin	x	x					Not progress
0000006_171018	2020/09/17 10:18	admin	x	x	admin	2020/11/10 09:01	admin		Request in progress
0000005_171045	2020/09/17 10:00	admin	x	x					Not progress
0000006_171829	2020/09/17 08:29	admin	x	x					Not progress

OK

Data status

21 CFR Part 11 Approval

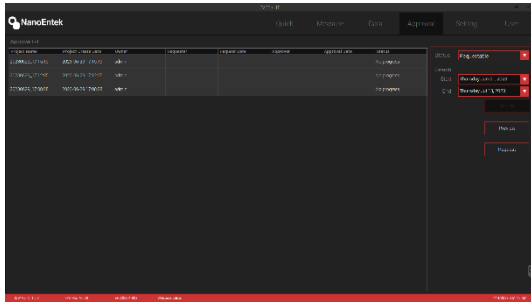

Approval

The list shows data that can be requested for approval.

1. Select the data to get approve.
2. Click the **'Request'** button.

Requestable

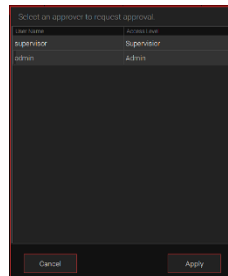

3. Select an approver to request approval.
4. Click the **'Apply'** button.

The requesting data are displayed.
It is possible to **'Cancel'** the request for approval.

The approver can approve the request in Requesting tab. The approval no need to log in to the approval ID.

Requesting

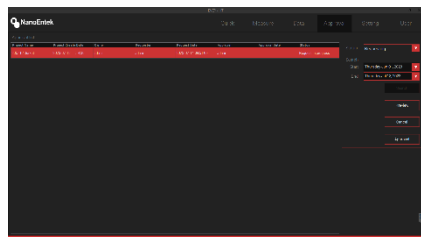

21 CFR Part 11 Approval

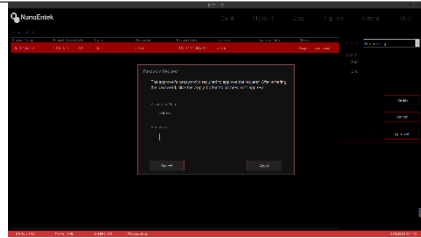

1. Select the Data in list
2. Click the 'Approval'
3. Enter the password.

The approvable data are displayed on this tab.
It is possible to **Reject** or **Approval**.

Approvable

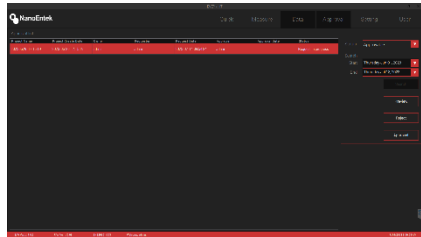

Approved

The approved data is listed.
It is possible to **Export** the Approved data.
All status data can be previewed in PDF format.

Preview

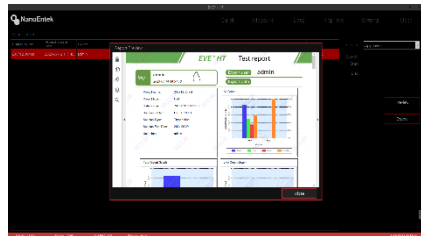

21 CFR Part 11 Setting

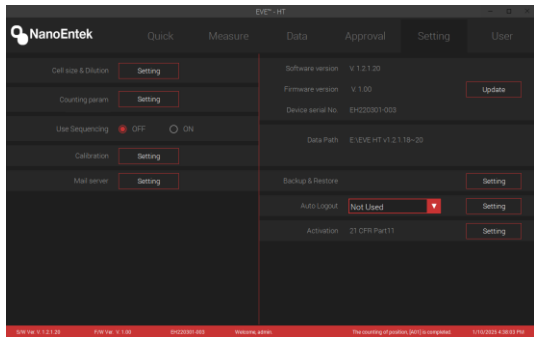

Setting tab after 21 CFR Part 11 activation

1. Backup & Restore

- 1 Click the Backup & Restore '**Setting**' button.

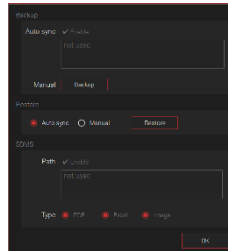

- 2 To enable automatic backup, click the Auto sync 'Enable', set the backup data path.
- 3 Click the Manual '**Backup**' button, save the backup data at the current point in time.
- 4 The Restore function provides two options. You can back up based on the backup data saved by Auto sync or the backup data saved by Manual.
- 5 Click the SDMS Path 'Enable', set the SDMS data path.
- 6 Select the desired type of SDMS data.

2. Auto Logout

- 1 Click the '▽' button

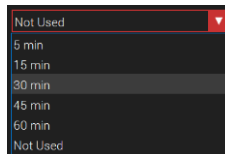

- 2 Select the auto logout limit time.
- 3 Click the Auto Logout '**Setting**' button.

21 CFR Part 11 User manage

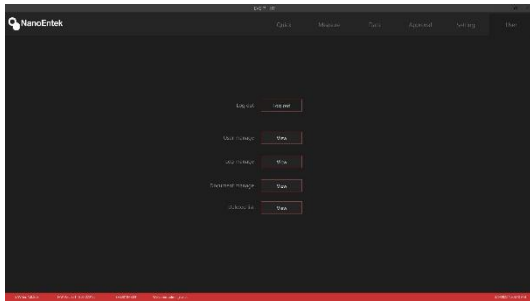

User tab

1. User management

Click the User manage 'View' button.

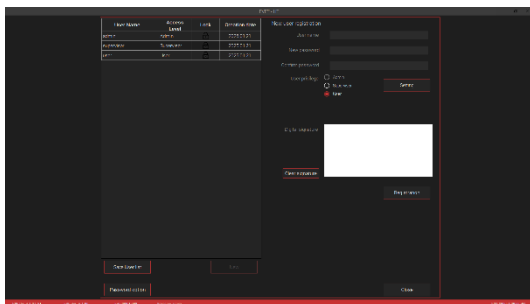

a) New user registration.

- ① Enter the user ID and PW.
- ② Click the User privilege 'Setting'.
- ③ Set the User privilege in each menu.

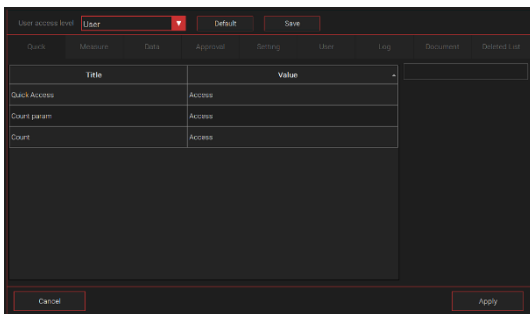

* User and Supervisor **default permission** settings can be changed.

- ✓ Set the privilege and click the 'save' button.
- ✓ See the 21 CFR part 11 Supplement for default settings.

- ④ Set the User and Supervisor permission.
- ⑤ Click the 'Apply' button.
- ⑥ Enter the signature and Click the 'Registration'

21 CFR Part 11

User manage

b) Edit the user option

- 1 Select the **user** in user list.

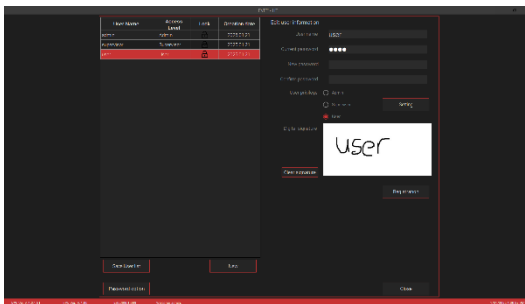

- 2 Do the same process in **Creating New user**.
- 3 Depending on the user's granted privileges, the account can be locked.

c) Password option

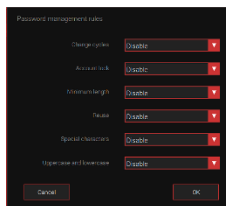

Set the password management rules.

- 1 Change cycles
Disable, 30 days, 60 days, 180 days
- 2 Account lock
Disable, ≥ 3 times, ≥ 5 times, ≥ 10 times, ≥ 15 times
- 3 Minimum length
Disable, ≥ 3 , ≥ 5 , ≥ 10 , ≥ 15
- 4 Reuse
Disable, ≥ 30 days, ≥ 60 days, ≥ 180 days
- 5 Special characters
Disable, Enable
- 6 Uppercase and lowercase
Disable, Enable

d) Lock in user list

User Name	Access Level	Lock	Creation date
admin	Admin		2025 01 21
supervisor	Supervisor		2025 01 21
user	User		2025 01 21

User ID is locked when login fails. Lock icon turns red. Click the button to unlock user ID and the button changes to grey.

21 CFR Part 11

Log manage, Document manage, Deleted list

1. Log manage

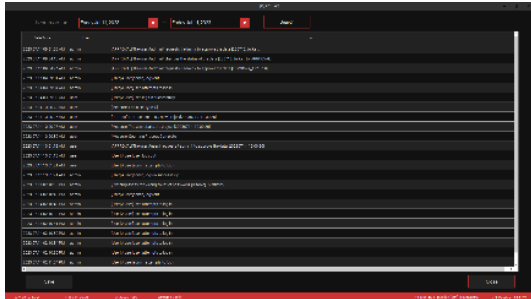

This 'Log manage' allows you to view a list of instrument log.
* Every logs can be saved in CSV file.

2. Document manage

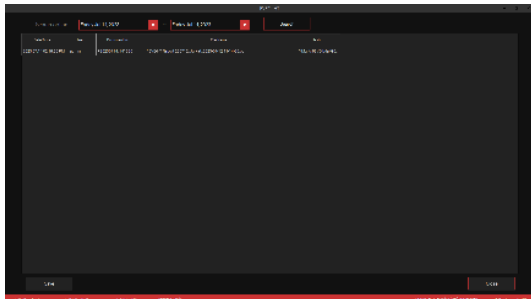

This 'Document manage' allows you to check the documents made in the equipment.

3. Deleted list

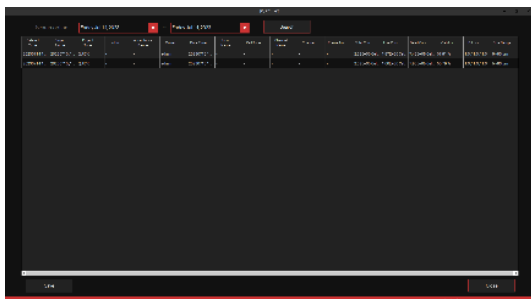

This 'Deleted list' allows you to view a list of deleted data.

** EVE-HT provides a comprehensive solution to comply with the requirements of the 21 CFR Part 11 rule.*

** Please see the appendix for more information on these features.*

Maintenance and Cleaning

Clean the surface of EVE™ HT with a damp cloth.

The EVE™ HT does not need regular maintenance. To troubleshoot problems with the instrument, contact technical support. Do not perform any repairs or service on EVE™ HT to avoid damaging the instrument.

Trouble Shooting

Inaccurate result

1. Low and high results

- EVE™ HT is designed to read samples from 1×10^4 cells/mL to 1×10^7 cells/mL.
- If your sample is out of this range, you may need to dilute the sample or add more cells and read the sample again.

2. Dilution factor

- Check the mixing ratio of Sample 20 μ L + Trypan blue 20 μ L. Mix ratio is already applied so do not apply to dilution factor.
- Apply sample dilution to the dilution factor.

3. Dust or bubble

- Check the surface of EVE™ HT Counting Plate.
- Be careful not to make any bubble when mixing and loading sample with a pipette.
- Put trypan blue to room temperature for warm up before use in order to avoid debris.
- Set the 'Counting parameter' before count in Focus setting window. Refer to pages 13-14.
- Remove any bubble and dust in the image after count using the image edit function Refer to pages 40.

4. Incorrect focus

- Set the correct focus. Refer to page 20-21.

5. Background calibration

- Too bright or too dark background affects the result.
- Do the Background calibration in the Setting tab, when using trypan blue with a new lot number. Refer to page 11.

6. Too big or too many clumpy cell

- Ensure the cells are not clumped.

7. Plate

- Push the plate all the way in.

Saving problems

1. E-mail

- Check the internet connection.

2. USB

- Check the storage path.

Error Message

Error Message

Error message	Solution
The EVE device is off. Please turn the EVE on and restart the EVE software. Please press the 'OK' button to finish the EVE software.	Turn on EVE™ HT prior to the EVE™ HT software.
Please insert a plate to use the EVE-HT.	Make sure put the plate all the way in.
Please close the holder to use the EVE-HT.	Close the cover of plate holder.
Please close the door to use the EVE-HT.	Close the door completely.

If the same error message appears repeatedly, contact your local distributor or sales@nanoentek.com.

Warranty

Under normal use, NanoEntek warrants that EVE™ HT shall be free from defects in material and workmanship for a period of one (1) year from the date of original purchase.

If any defects occur in EVE™ HT during this warranty period, NanoEntek will repair or replace the defective parts at its discretion without charge.

The following defects, however, are specifically excluded:

1. Defects caused by improper operation.
2. Repair or modification done by anyone other than NanoEntek or an authorized agent.
3. Damage caused by substituting alternative parts.
4. Use of fittings or spare parts supplied by anyone other than NanoEntek.
5. Damage caused by accident or misuse.
6. Damage caused by disaster.
7. Corrosion caused by improper solvent or sample.

For your protection, EVE™ HT to be returned must be insured against possible damage or loss. NanoEntek will not be responsible for damage incurred during shipment of the defective instrument. It is recommended that you save the original packing material in which the instrument was contained. This warranty is limited to the replacement of defective products.

For any inquiry or request for repair service, please contact sales@nanoentek.com or your local distributor.

Technical Specifications

EVE™ HT	
Measuring range	1 x 10 ⁴ ~ 1 x 10 ⁷ cells/mL
Analysis time	< 3 minutes / 48 tests
Light	Bright
Number of channel	1
Cell size	5 ~ 80 μm
21 CFR Part 11	Available
Operation System	Windows 10 Enterprise LTSC
Size (W x D x H)	586 mm (W) x 461 mm (D) x 458 mm (H)
Weight	58 kg

Operation	
Temperature	5°C ≤ Temperature ≤ 40°C
Humidity	20% ≤ Humidity ≤ 80%
Altitude	Altitude ≤ 2,000 m

Accessories	
Multi pipette	1 ea

EVE™ HT Counting kit	
Counting plate	15 ~ 30°C (59 ~ 86°F)

Solutions	
Trypan blue	15 ~ 30°C (59 ~ 86°F)

Storage temperature	
Counting plate	15 ~ 30°C (59 ~ 86°F)
Trypan blue	15 ~ 30°C (59 ~ 86°F)

Expiration Date	
Counting plate	2 years
Trypan blue	Check the reagent label 6 months after opening

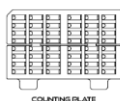

COUNTING PLATE



RESERVOIR



TRYPAN BLUE

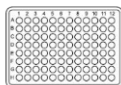

WELL PLATE

Ordering information

Cat. No.	Description	Contents
EVE HT	A High-throughput multi-cell counter	Main device 1 ea Desktop & monitor 1 set Multi-pipette 1 ea
EVH-020	EVE™ HT Counting kit	960 tests / kit Counting plate (48 channels × 20 plates) Mix well plate (96 wells × 10 plates) Trypan blue solution (0.4%, 20 mL × 2 bottles) Reservoir (20 pcs)
EHPQ-001	EVE™ HT QC plate (optional)	Low level, 1 pc
EHPQ-002	EVE™ HT QC plate (optional)	Middle level, 1 pc
EHPQ-003	EVE™ HT QC plate (optional)	High level, 1 pc
EHB-001	EVE HT Test Beads (optional)	1 x 1 mL / Pack
EHPP-001	EVE™ HT Preparation plate (optional)	Preparation plate
EVE HT 21 CFR Part 11	EVE™ HT 21 CFR Part 11 software (optional)	21 CFR Part 11 software

Safety Precautions

Review and follow the safety instructions below:

- If water or other material enters the instrument, the adaptor, or power inlet disconnect the power cord and contact a service person. For operation in a humid environment, refer to Product Specifications.
- Do not touch the main plug or power cord with wet hands.
- Always ensure that the power supply input voltage matches the voltage available at your location.
- This instrument is air-cooled and its surfaces may become hot during operation. When installing, leave a space of more than 10 cm (4 inches) around the instrument and do not place any objects between the instrument and walls.
- Do not install an instrument on a slant or a place prone to vibrations, which induces the risk of malfunction or damage of the instrument.
- Never insert any objects into the air vents of the instrument as this can result in electric shock, personal injury, and equipment damage.
- Plug the power cord firmly into the wall outlet and AC adapter.
- To avoid potential shock hazard, make sure that the power cord is properly grounded.
- Be sure to position the instrument such that it is easy to disconnect.
- Turn off an instrument before unplugging the power cord and/or moving the instrument.
- If an instrument is dropped or broken, disconnect the power cord and contact a service person. The warranty will be void in case of disassembly.
- Use only authorized accessories (adaptor, power cord, and USB drive).



Class A equipment is intended for use in an industrial environment. In the documentation for the user, a statement shall be included drawing attention to the fact that there may be potential difficulties in ensuring electromagnetic compatibility in other environments, due to conducted as well as radiated disturbances.

Mesures de sécurité

Examiner et suivre les instructions en matière de sécurité ci-dessous:

- Si de l'eau ou d'autres matières entrent dans l'instrument, l'adaptateur, ou l'entrée de la prise, débrancher le cordon d'alimentation et contacter un technicien de service. Pour l'environnement d'exploitation, se reporter aux Spécifications du Produit.
- Ne pas toucher la prise principale ou le cordon d'alimentation avec les mains mouillées.
- S'assurer toujours que la tension d'alimentation correspond à la tension disponible à votre localisation.
- Cet instrument est refroidi à l'air et ses surfaces peuvent devenir chaudes pendant le fonctionnement. Lors de l'installation, laisser un espace de plus de 10 cm (4 pouces) autour de l'instrument et ne placer aucun objet entre l'instrument et les murs.
- Ne pas installer d'instrument sur une pente ou un endroit sujet aux vibrations qui entraînent un risque de défaillance ou de détérioration de l'instrument.
- Ne jamais insérer d'objets dans les événements d'air de l'instrument, car cela peut causer des chocs électriques, des blessures corporelles et des dommages de l'instrument.
- Mettre le cordon d'alimentation fermement dans la prise murale et l'adaptateur courant alternatif.
- Pour éviter tout risque de choc, s'assurer que le cordon d'alimentation est correctement mis à la terre.
- S'assurer de positionner l'instrument de telle sorte qu'il soit facile à débrancher.
- Éteindre l'instrument avant de débrancher le cordon d'alimentation et/ou de le déplacer.
- En cas de chute ou de rupture d'un instrument, débrancher le cordon d'alimentation et contacter un technicien de service. La garantie sera annulée en cas de démontage.
- Utiliser uniquement les accessoires autorisés (adaptateur, cordon d'alimentation et clé USB).





















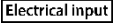

AVERTISSEMENT

L'équipement de classe A est destiné à être utilisé dans un environnement industriel. Dans la documentation pour l'utilisateur, une déclaration doit être incluse pour attirer l'attention sur le fait qu'il peut y avoir des difficultés à assurer la compatibilité électromagnétique dans d'autres environnements, en raison de perturbations aussi bien conduites que radiées.

Explanation of Safety Symbols

The following symbols are found on the medical device and this document. Always use the instrument in the safest possible manner.

Symbol	Meaning
	Caution & Warning
	Protective earth (Ground)
	Power On/Off
	The moving parts symbol indicates areas of the medical device in which moving parts can cause injuries. Do not operate the medical device with the door open.
	This equipment has been tested and found to comply with the limits for a Class A digital medical device, pursuant to Part 15 of the FCC Rules. These limits are designed to provide reasonable protection against harmful interference when the equipment is operated in a commercial environment. This equipment generates, uses, and can radiate radio frequency energy and, if not installed and used in accordance with the instruction manual, may cause harmful interference to radio communications. Operation of this equipment in a residential area is likely to cause harmful interference in which case the user will be required to correct the interference at his own expense.
	This medical device and consumables conforms to the EC Declaration of Conformity.
	USB Connection
	This product conforms to UL 61010-1, CAN/CSA C22.2 No.61010-1 "Safety Requirements for Electrical Equipment for Measurement, Control, and Laboratory Use, Part I: General Requirements." This instrument bearing the TÜV symbol are certified by TÜV Product Services to be in conformance with the applicable safety standard for the US and Canada.
	Catalogue number/Reference number
	Serial number
	Manufacturer
	Electrical input
 www.nanoentek.com/eifu.php	Consult Instructions for Use An electronic instructions for us (eLFU) indicator (website address) may accompany the symbol when used to indicate an instruction to consult an eLFU.

 www.nanoentek.com/eifu.php	<p>Consult Instructions for Use</p> <p>An electronic instructions for us (eLFU) indicator (website address) may accompany the symbol when used to indicate an instruction to consult an eIFU.</p>
	<p>Disposal of your old appliance</p> <ol style="list-style-type: none"> 1. When this crossed-out wheeled bin symbol is attached to a product it means the product is covered by the European Directive 2012/19/EU. 2. All electrical and electronic products should be disposed of separately from the municipal waste stream via designated collection facilities appointed by the government or the local authorities. 3. The correct disposal of your old appliance will help prevent potential negative consequences for the environment and human health. 4. For more detailed information about disposal of your old appliance, please contact local distributor, waste disposal service or call the number listed in the manual.
	<p>LED</p>
	<p>Physician. Keep dry Keep away from rain</p>
	<p>Fragile, handle with care</p>
	<p>This way up</p>
	<p>General symbol for recover/recyclable</p>
	<p>Team lift</p>
<p>US Corporation</p>	<p>US Corporation</p>
<p>European Corporation</p>	<p>European Corporation</p>
<p>EC REP</p>	<p>Authorized representative in the European community</p>
<p>UK Representative</p>	<p>Authorized representative in United Kingdom</p>
<p>CH REP</p>	<p>Authorized representative in Switzerland</p>
<p>BRH</p>	<p>Authorized representative in Brazil</p>

Warnings



1. After using this medical device, please turn off the main power. If not, it may cause malfunction or lifetime reduction of medical device.

2. When turning off the medical device, make sure to lock the device by pressing 'Lock' button. If not, it may cause mechanical problem(s) or error message will appear during the device booting.

Item	Warning
Cover	Do not remove cover or disassemble case. There are no adjustable components inside the device. If malfunction occurs, please contact an authorized service person.
Manual	Do not attempt to service the device. This manual is only available in English. Failure to heed warnings may result in injury to service provider or operator.
Sample handling	Wear personal protective instrument during sampling and testing. Sample may contain infectious or bio-hazardous agents. Use of capped tubes and lint free wipes. Used lint free wipes shall be discarded.
Waste	After using the plate, dispose appropriately as bio-hazards waste. Do not reuse the plate.

Technical Support

Visit our Website at www.nanoentek.com for:



- Technical resources, including manuals, FAQs, etc.
- Technical support contact information
- Additional product information and special offers

For more information or technical assistance, please call or email.

NanoEntek, Inc.

851-14, Seohae-ro, Paltan-myeon, Hwaseong-si,
Gyeonggi-do, 18531, Korea
Tel: +82-2-6220-7940
Fax: +82-2-6220-7999

NanoEntek America, Inc.

220 Bear Hill Road, Suite 102, Waltham, MA 02451, USA
Tel: +1-781-472-2558
Fax: +1-781-790-5649

NanoEntek Europe I med-tech supplies GmbH

Lochhamerstr. 4a, 82152 Martinsried, Germany
Tel: +49-89-21-55-38-43 / Fax: +49-89-99-95-46-60

Email

sales@nanoentek.com

Website

www.nanoentek.com

EVE™ HT

NESMU-EVEHT-001E (V.0.4)



NanoEntek, Inc.

851-14, Seohae-ro, Paltan-myeon,
Hwaseong-si,
Gyeonggi-do, 18531, Korea
Tel: +82-2-6220-7940
Fax: +82-2-6220-7999

US Corporation

NanoEntek America, Inc.

220 Bear Hill Road, Suite 102, Waltham, MA 02451, USA
Tel: +1-781-472-2558
Fax: +1-781-790-5649

European Corporation

NanoEntek Europe I med-tech supplies GmbH

Lochhamerstr. 4a, 82152 Martinsried, Germany
Tel: +49-89-21-55-38-43 / Fax: +49-89-99-95-46-60

Email

sales@nanoentek.com

Website

www.nanoentek.com